

LITHIUM THIONYL CHLORIDE CELL

Technical Overview

Open Circuit Voltage (25°C)	3.6 V
Rated Discharge Current	100 uA
Rated Capacity	1.0 Ah
Maximum Continuous Current	1.0 mA
Cell Diameter	25.4 mm (1.001 in.)
Cell Height (excluding pins)	7.5 mm (0.297 in.)
Cell Weight	10 g
Lithium Weight	0.4 g
Self Discharge	3% per year at 25°C
Operating Temperature	-40°C to +85°C
	-40°F to +185°F

NOTE: This product and its external electrical contact materials are RoHS compliant. See our "RoHS Statement" for more information.

Dimensions

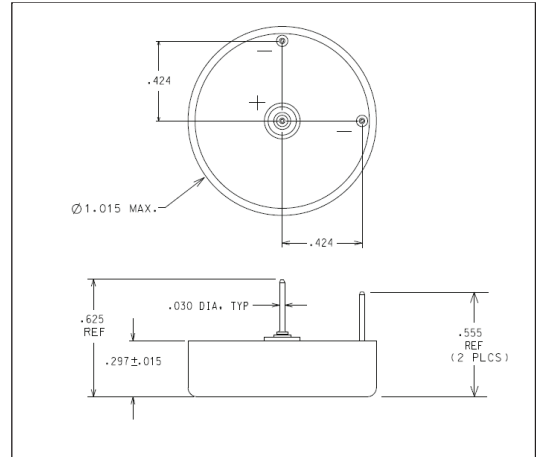

Key Features:

- Primary chemistry (non-rechargeable)
- Low rate capability
- Bobbin style construction
- Stainless steel container
- Hermetic glass-to-metal sealing
- Wide operating temperature range as low as -40°C and up to +85°C
- Low self discharge rate (3% per year at 25°)
- Custom terminations available

Main Applications:

- Memory back-up
- Animal telemetry
- Low current downhole oil and gas

NOTE: This list does not include all potential applications, please consult Electrochem for your specific application needs.

25°C discharge

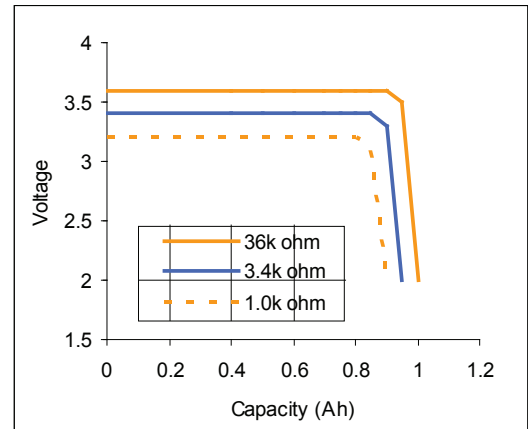

NOTICE: The information on this datasheet is for single cells only. Please consult with Electrochem if you are interested in additional information. The information in this document is subject to change without notice and does not constitute a warranty of performance.